

MISUTONIDA

italian style accessories **4x4**

KIA SORENTO 06/08



Item Code

: **GP/188/IX**

Codice Articolo

GPO/188/IX

Référence Article

DSP/188/IX

GB

STAINLESS STEEL GRAND PEDANA
OVAL GRAND PEDANA









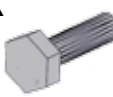

ITA

GRAND PEDANA/GRAND PEDANA
OVALE IN ACCIAIO INOX

FR

GRAND PEDANA/GRAND PEDANA
OVAL EN ACCIER INOX

KIA SORENTO 06/08

Part List Lista della bulloneria Liste des pièces		
A  TE 10X50 x 4	I  Ø 6 x 4	
B  M10 Autoblocking Autobloccante Autobloquant x 4	L  S/188/P x 2	
C  GP 188 x 4	M  S/188/A x 2	
D  Ø 8 x 4		
E  Ø 8 x 4		
F  M8 x 4		
G  TE 6X25 x 4		
H  Ø 6 x 4		

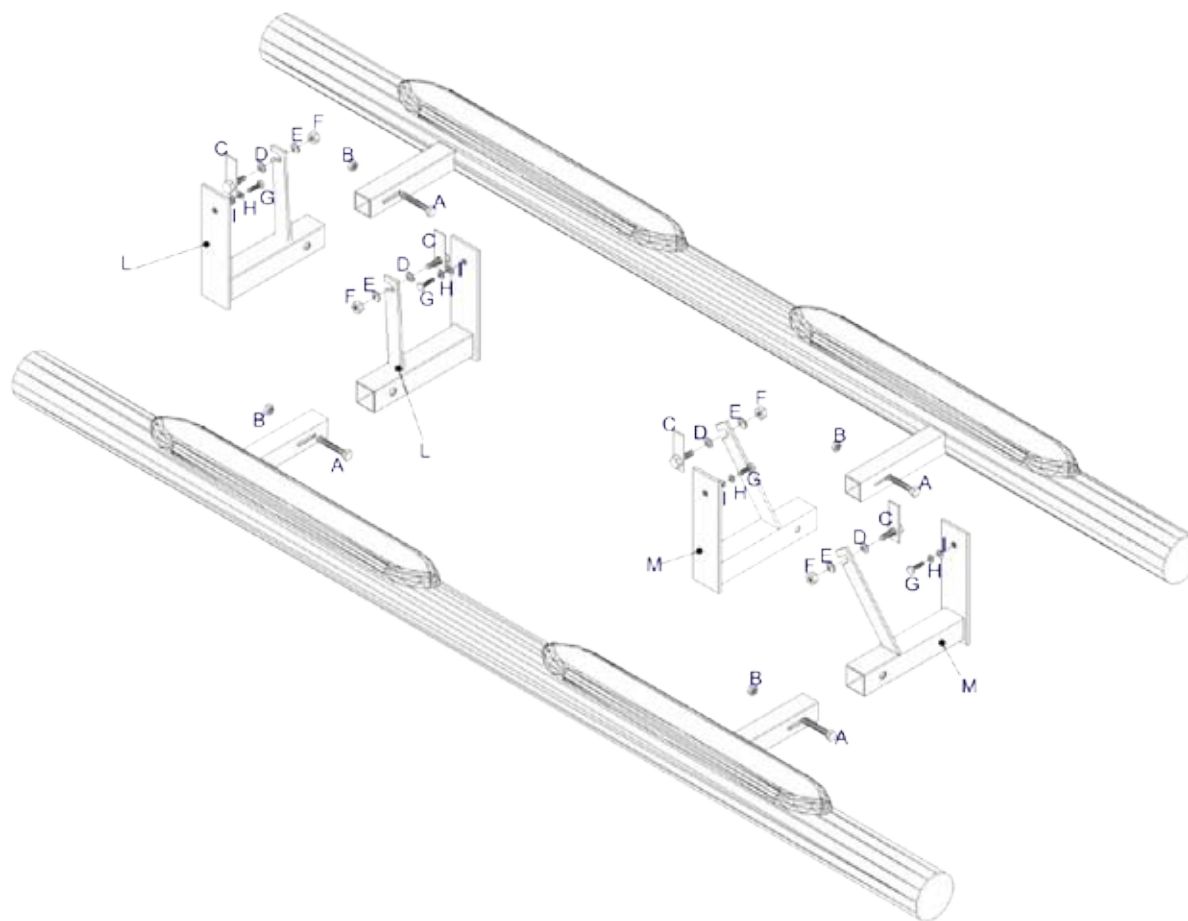

 **MISUTONIDA**
  *italian style* **4x4**
accessories

GB

FITTING INSTRUCTIONS

1. Remove the n. 4 plastic caps (pictures 1 and 2)
2. Insert C with D in the holes just freed (pictures 3 and 4).
3. Fit L and M on C as shown in picture 5 and tighten all.
4. To fix more tight L and M to the chassis use G,H and I in the threaded hole already present as shown in picture 6.

WARNING: For the fitting of the rear right stand (L) remove the TE that blocks the pipes (see picture 7) and fit L under the small bracket present on the chassis.

Use the supplied TE (G) to fix L (picture 8).

ITA

ISTRUZIONI DI MONTAGGIO

1. Rimuovere i 4 tappi in gomma (foto 1 e 2).
2. Inserire C con D nei fori appena liberati (foto 3 e 4).
3. Montare L e M su C come indicato nella foto 5 e serrare il tutto.
4. Per fissare ulteriormente L e M al telaio utilizzare G,H ed I nel foro filettato già esistente (foto 6).

ATTENZIONE: Per il montaggio del supporto posteriore destro (L) rimuovere il TE che blocca i tubi (vedi foto 7) e montare L sotto la staffetta che sorregge i tubi.

Utilizzare il TE in dotazione (G) per fissare L (foto 8)

FR

INSTRUCTIONS DE MONTAGE

1. Enlever les n.4 bouchons en plastique (photos 1 et 2).
2. Insérer C avec D dans les trous filetés libérés (photos 3 et 4).
3. Monter L et M sur C comme indiqué dans la photo 5 et serrer tout.
4. Pour fixer ultérieurement L et M au châssis utiliser G,H et I dans le trou fileté déjà présent (photo 6).

ATTENTION: Pour le montage du support postérieur droit (L) enlever le TE qui bloque les tubes (photo 7) et monter L sous le petit étrier qui soutient les tubes.

Utiliser le TE fourni (G) pour fixer (photo 8).



Date Data Date	Item Code Cod.Articolo Réf. Article	Vehicle model Modello Veicolo Modèle de Voiture
03/10/06	GP/188/IX GPO/188/IX DSP/188/IX	KIA SORENTO 06/08

Checked and approved by
Controllato ed approvato da
Controlé et approuvé par

**Claudio
Gallo**